

THE CLUB OF ROME

THE PREDICAMENT OF MANKIND: A Quest for Structured Responses to Growing
World-wide Complexities and Uncertainties

A PROPOSAL from 1970

TABLE OF CONTENTS

SECTION ONE: Work Statement & Proposal (green pages)

- I. INTRODUCTORY
- II. THE CLUB OF ROME
- III. THE PROBLEMATIQUE: AN OVERVIEW OF THE SITUATION
- IV. THE PROPOSAL

SECTION TWO: Conceptual Frame & Work Procedures (white pages)

- I. INTRODUCTION: THE CONCEPTUAL FRAMEWORK
- II. TENTATIVE PLANNING CONSTRUCT
- III. GENERAL COMMENTS ON METHODOLOGY
- IV. MODEL OF WORK PROCESS AS PRESENTLY ENVISAGED

SECTION THREE: Annexes (pink pages)

- ANNEX I: THE CLUB OF ROME
- ANNEX II: THE IDEA OF A WORLD FORUM
- ANNEX III: THE EXECUTIVE COMMITTEE
- ANNEX IV: THE WORK GROUP
- ANNEX V: CONSULTANTS

SECTION ONE: Work Statement and Proposal

I. INTRODUCTION

As in every epoch of its existence, mankind today finds itself in a particular "situation". And as always this situation is created and nurtured by those who live amid the myriad events that comprise it --events that now are in the process of tumultuous and ever accelerating change, events that now increasingly and even violently clash with one another. In some deep sense our situation compels us to animate and perpetuate it almost blindly, and thus to move toward a future whose shape or quality we do not comprehend, whose surprises we have not succeeded in reducing to a rational frame of ideas, whose complexities we are not in the least sure of being able to control.

There are, however, a few basic perceptions that possess both wide currency and increasing persuasiveness, by means of which people in many different walks of life have begun to apprehend the nature of this situation. It is thanks to such perceptions that we have come to recognize the forces that hold us in their grip as arising from what we have

long recognized as being the very source of our power and achievement --at least in those countries where the industrial mode of life has flourished and broken the back of age-old scarcities.

The source of our power lies in the extraordinary technological capital we have succeeded in accumulating and in propagating, and the all-pervasive analytic or positivistic methodologies which by shaping our minds as well as our sensibilities, have enabled us to do what we have done. Yet our achievement has, in some unforeseen (perhaps unforeseeable) manner, failed to satisfy those other requirements that would have permitted us to evolve in ways that, for want of a better word, we shall henceforth call "balanced." It has failed to provide us with an ethos, a morality, ideals, institutions, a vision of man and of mankind and a politics which are in consonance with the way of life that has evolved as the expression of our success. Worse, it has failed to give us a global view from which we could begin to conceive the ethos, morality, ideals, institutions, and policies requisite to an inter-dependent world --this, despite the fact that the dynamics of our technologies and of our positivistic outlooks are global in their impacts, their consequences, their endless profusion and, more importantly, in the promises they proclaim and in the promises they imply.

This failure is often regarded as having created a number of separate and discrete problems capable of being overcome by the kind of analytic solutions our intellectual tradition can so readily generate. However, the experience of the past twenty or thirty years has shown with remarkable clarity that the issues which confront us in the immediate present, as well as their undecipherable consequences over time, may not too easily yield to the methods we have employed with such success in the bending of nature to our will. Such apparent resistance could be attributable to many things, none of which must be pre-judged, but about which certain assumptions might be made. It could be due, for instance, to the magnification of the problems we must grapple with --that is, to the fact that almost all of them are global in scope, whereas the socio-political arrangements we have created are ill-equipped for dealing with issues that fall outside their strictly established jurisdictions. It could be due to heightened yet often obscure interactivity among phenomena, whereas our manner of solving problems owes its strength and efficiency to the identification of rather clear and direct lines of causality. It may be due to rapid rates of change, especially in the technological sector, whereas our institutions, outlooks and minds are geared by long-time habit to beliefs in slow unfolding and permanence --beliefs which have sustained certain relatively stable concepts of polity, of social order and of intellectual orderliness. In brief, whatever it is due to, the conjuncture of events that surrounds us is to all evidence worldwide, complex, dynamic, and dangerous.

Moreover such a situation can be seen as a new, or novel, experience, for in our long commitment to stability and continuity we have hitherto succeeded more or less, in steering our social evolution toward the known and in avoiding that which, for being unknown, was also uncertain and, therefore, frightening.

Because of the dissonances that inhere in our situation we find that our current attitudes toward life and issues are tending to become rigidly polarized and in consequence, hesitant to the point of paralysis. On the one hand, we take refuge in the comforts of that inertia we believe is going to help us preserve all the attributes of what we have come to call and to accept as "civilization". On the other hand, we tend to seek escape in

iconoclastic or utopian futurisms whose feasibility and intellectual worth we know to be questionable, but in whose visions of a wholly new human order we sometimes find solace as well as some fleeting release.

These contradictory attitudes toward uncertainty are old. However, it bears repeating that the uncertainty, as we experience it today, is new --both in its dimensions and in its extraordinarily complex dynamics and structure. From this fundamental mismatch between the situation, that we still insist on describing as a set of "problems," and our mental and emotional attitudes, which we continue to feel might give birth to "solutions," we can already make the assumption that our notion of problem is wholly insufficient for us to face whatever it is that our situation proposes both to our intellect and to our conscience. At the same time our notions of solution are equally insufficient to enable us to define those outcomes that could or might result in novel ways of coping with our predicament --namely, of organizing our vision at a higher level where new approaches and attitudes might begin to acquire a degree of immediate relevance.

It is the aim of this particular project of the Club of Rome to turn the above assumption into a positive statement, by trying to cognize and investigate the all-pervasive problematique which is built into our situation, through some new leap of inventiveness. Success in an attempt of this nature would enlarge and deepen both our sensibility and our understanding and open the way for certain new attitudes that eventually might become reflected, concretely and operationally, at those levels of decision making where policy is formulated.

In the making of such an effort the factor of time has acquired the utmost importance, for rapid change which is a crucial aspect of our technological momentum is accompanied by a parallel phenomenon: the similarly rapid and massive crystallization of any corrective action we devise and apply to single problems, to the discrete components of the situation. If our initial surmise that such partial cures are either insufficient or irrelevant is correct, it follows that every such action exacerbates the problematique as a whole and adds certain irreversible features to it. This, then, must lead us to conclude that time is not only of the essence but an absolute imperative that must condition any undertaking which seeks a new approach to the dilemma of our age.

This point is well illustrated by some recent studies concerning "decision effectivity time." Such studies indicate that any corrective or beneficent effects of present action are dependent on varying time-spans, and that in many instances these time-spans have narrowed down to a critical minimum. A number of types of crisis have been singled out whose flash-points could now be seen as clustered well within the decade of the 1970's. Thus, effectivity margins that apply to general problem classes such as large-scale destruction or change, widespread tensions, continuous and growing distress, tension producing responsive change, etc., are increasingly conceived as probably falling within a 1-7 year range (nuclear escalation, 1-5 years at the outset; institutional insufficiencies, 3-5 years; participatory impatience which is one of the main factors feeding the alienation of our youth, 3-4 years; widening famine, 5-7 years; pollution, housing, education, etc., 3-7 years). These random instances serve to show that if something is to be done it needs to be done now --for otherwise we might be confronted by that ultimate experience: N-E-V-E-R.

Such then is the predicament of mankind, and the object of this document is to describe, in terms that are perforce still somewhat cursory, what can be done now, the issues that must be addressed, the organization of the needed effort, its scope and its program, the methods of investigation that appear pertinent and the outcomes which, a priori, one might hope for.

The document is divided into three parts. The present first section contains an overall description of the above points. The second section is an attempt to discuss in a very general way some of the methods of approach and organization that could be considered at this stage as possibly being useful in an undertaking of this kind. The last section consists of various clarificatory annexes describing, among other things, the aims, plans, and general philosophy of the Club of Rome. A few comments on these aims, which directly relate to the present project, follow.

II. THE CLUB OF ROME

The Club of Rome is an informal, non-political, multi-national group of scientists, intellectuals, educators, and business leaders deeply concerned with the situation just sketched, who among them have decided to face the issues that confront mankind in any way which offers the hope of reaching a new level of understanding and therefore of successful action.

The members of this group have access to considerable sources of information and knowledge. Acting jointly, they believe that they can mobilize enough intellectual and financial support to try to undertake the present project that should be viewed, not as another research study, but as an effort at intellectual breakthrough that promises a fresh vision and approach. It is their belief that only an effort which strives to go beyond "conventional wisdom" and methodological orthodoxy can allow us to perceive the complex dimensions of the problematique of our age, and thus set the stage for the formulation and development of the long-term options and alternative outlooks needed for policy-making. They are further convinced that a group of private persons who while concerned are nevertheless free from the responsibility of day-to-day political decision -- and who, as individuals, have no political ambition except the good of mankind and its survival -- can contribute in this way to the work of those who are responsible for leadership and action.

With reference to the project under consideration, the major objectives of the Club of Rome are:

- To examine, as systematically as possible, the nature and configuration of the profound imbalances that define today's problematique throughout the world, and to attempt to determine the dynamics of the interactions which seemingly exacerbate the situation as a whole.
- To develop an initial, coarse-grain, "model" or models of this dynamic situation in the expectation that such models will reveal both those systemic components that are most critical and those interactions that are most generally dangerous for the future.
- To construct a "normative" overview from the foregoing models and to clarify the action implications --i.e., the political, social, economic, technological,

institutional, etc., consequences --that such an overview might entail and substantiate.

- To bring everything that has been learnt as a result of this initial effort, to the attention of those in political authority, in the hope that such findings might stimulate the conception of new lines of policy that would be effective in coping with our situation's overall dynamics and its world-wide dimensions.
- To persuade governments to convene a World Forum,*¹ with whose consent, support, and encouragement an intensive dialogue concerning the findings of the project would be initiated to the end that a much larger and deeper effort could be undertaken. Such an effort would aim at developing the needed operational "macro-models" conducive to endeavors at integrated policy-planning and to the development of new institutions within whose frame of competence such work could be carried out.

These objectives have been set with the full knowledge that many governments and international organizations are beginning to recognize the dangers with which our present situation is fraught. Thus on the international level bodies such as NATO or OECD are now undertaking detailed work on many individual issues, while the United Nations is planning a world conference on the problems of the "Environment" in 1972. These moves are welcome and should add greatly to our recognition and understanding of the grave matters that are facing the whole of mankind.

Nevertheless, the prime difference between these approaches and the one being proposed by the Club of Rome must be noted. It resides in the fact that most current efforts are directed toward single or parallel problems and do not attempt any consistent and comprehensive study of the totality of the problematic events that add up to our world system; nor do they address themselves to the areas of dynamic interaction or of overall consequences of these events; nor, for that matter, are they explicitly concerned with questions of institutional change, development, and invention which might be necessary to cope with what is confronting us.

The approach adopted by the Club of Rome, on the other hand, derives from the threefold hypothesis:

- that the predicament we seek to understand is systemic in character; and that the boundaries of the system encompass the entire planet;
- that the real problematique which inheres in the situation has now transcended discrete categories of events --overpopulation, malnutrition, poverty, pollution, etc. -- and arises from confused and obscure consequence- patterns generated by the interactions of such categories of events;
- that any desirable, or even acceptable, resolution of the problematique will in all probability entail, at least as outcomes to be seriously considered, fundamental changes in our current social and institutional structures, for the simple reason that these structures were not established to operate in so complex and dynamic a situation as the one in which we find ourselves.

III. THE PROBLEMATIQUE:

¹ *For further information regarding this point, please see Annex II in the last section of this document.

AN OVERVIEW OF THE SITUATION

1. THE IDEA OF "PROBLEMATIQUE"

It is in the nature of our languages, hence of our manner reality, to see and call the dissonant elements in a situation, "problems".

Similarly, we proceed from the belief that problems have "solutions" --although we may not necessarily discover these in the case of every problem we encounter. This peculiarity of our perception causes us to view difficulties as things that are clearly defined and discrete in themselves. It also leads us to believe that to solve a problem it is sufficient to observe and manipulate it in its own terms by applying an external problem-solving technique to it.

Although it is true that there are certain problems (mostly in the field of technology and engineering) that can be dealt with in this way, it is also becoming quite evident that such problems are no longer the most important ones with which we must deal.

When we consider the truly critical issues of our time such as environmental deterioration, poverty, endemic ill-health, urban blight, criminality, etc., we find it virtually impossible to view them as problems that exist in isolation --or, as problems capable of being solved in their own terms. For even the most cursory examination will at least reveal the more obvious (though not necessarily the most important) links between problems. Where endemic ill health exists, poverty cannot easily be divorced from it, or vice versa. Certain kinds of criminal behavior often, though not always, seem to be related to poverty or slum living conditions. Furthermore, if we try to solve any such problems exclusively in their own terms we quickly discover that what we take to be the solution of one category of problem may itself generate problems of another category (the reduction of death rates in developing areas and the resultant increase in poverty, public unrest, overpopulation, etc., is a good example of this single avenue approach).

Another unfortunate consequence of the preference we display toward orthodox problem-solving is the misapplication of effort and energy. Thus many agronomists devote a great deal of ingenuity toward increasing the yield per acre of our crops without seeming to realize that the particular solution called "agriculture" may possibly no longer represent the single, feasible resolution of the problems clustered under words such as "hunger" or "malnutrition" when the latter are considered in their world-wide dimensions. It seems reasonable, therefore, to postulate that the fragmentation of reality into closed and well-bounded problems creates anew problem whose solution is clearly beyond the scope of the concepts we customarily employ. It is this generalized meta-problem (or meta-system of problems) which we have called and shall continue to call the "problematique" that inheres in our situation.

2. TOWARD A GENERALIZED RATIONALE

The fragmentation of reality caused by our conceptual and linguistic makeup notwithstanding, it is still necessary to talk about the situation and to communicate ideas concerning it. Since we have no new language for doing this, we can only approach the notion of the problematique in terms that are familiar to us. We can break down the problematique into its major components and we can list such components, both for

purposes of their tentative identification and of creating a referential base, under the title of Continuous Critical Problems. The listing that follows represents a general statement of the most commonly recognized problems of this sort.

CONTINUOUS CRITICAL PROBLEMS: AN ILLUSTRATIVE LIST

- 1) Explosive population growth with consequent escalation of social, economic, and other problems.
- 2) Widespread poverty throughout the world.
- 3) Increase in the production, destructive capacity, and accessibility of all weapons of war.
- 4) Uncontrolled urban spread.
- 5) Generalized and growing malnutrition.
- 6) Persistence of widespread illiteracy.
- 7) Expanding mechanization and bureaucratization of almost all human activity.
- 8) Growing inequalities in the distribution of wealth throughout the world.
- 9) Insufficient and irrationally organized medical care.
- 10) Hardening discrimination against minorities.
- 11) Hardening prejudices against differing cultures.
- 12) Affluence and its unknown consequences.
- 13) Anachronistic and irrelevant education.
- 14) Generalized environmental deterioration.
- 15) Generalized lack of agreed-on alternatives to present trends.
- 16) Widespread failure to stimulate man's creative capacity to confront the future.
- 17) Continuing deterioration of inner-cities or slums.
- 18) Growing irrelevance of traditional values and continuing failure to evolve new value systems.
- 19) Inadequate shelter and transportation.
- 20) Obsolete and discriminatory income distribution system(s).
- 21) Accelerating wastage and exhaustion of natural resources.
- 22) Growing environmental pollution.
- 23) Generalized alienation of youth.
- 24) Major disturbances of the world's physical ecology.
- 25) Generally inadequate and obsolete institutional arrangements.
- 26) Limited understanding of what is "feasible" in the way of corrective measures.
- 27) Unbalanced population distribution.
- 28) Ideological fragmentation and semantic barriers to communication between individuals, groups, and nations.
- 29) Increasing a-social and anti-social behavior and consequent rise in criminality.
- 30) Inadequate and obsolete law enforcement and correctional practices.
- 31) Widespread unemployment and generalized under-employment.
- 32) Spreading "discontent" throughout most classes of society.
- 33) Polarization of military power and psychological impacts of the policy of deterrence.
- 34) Fast obsolescing political structures and processes.
- 35) Irrational agricultural practices.
- 36) Irresponsible use of pesticides, chemical additives, insufficiently tested drugs, fertilizers, etc.
- 37) Growing use of distorted information to influence and manipulate people.

- 38) Fragmented international monetary system.
- 39) Growing technological gaps and lags between developed and developing areas.
- 40) New modes of localized warfare.
- 41) Inadequate participation of people at large in public decisions.
- 42) Unimaginative conceptions of world-order and of the rule of law.
- 43) Irrational distribution of industry supported by policies that will strengthen the current patterns.
- 44) Growing tendency to be satisfied with technological solutions for every kind of problem.
- 45) Obsolete system of world trade.
- 46) Ill-conceived use of international agencies for national or sectoral ends.
- 47) Insufficient authority of international agencies.
- 48) Irrational practices in resource investment.
- 49) Insufficient understanding of Continuous Critical Problems, of their nature, their interactions and of the future consequences both they and current solutions to them are generating.*²

It should be evident that these Continuous Critical Problems are meant merely to serve as general labels under each of which entire trees or clusters of issues that appear analogous, can be classified. Further, neither their rate of occurrence nor their intensity is uniform throughout the world. Therefore, the causality structure that underlies such a listing is obviously of extreme complexity and actually impossible fully to ascertain through mere observation for, even on direct empirical evidence, it is clear that the true list must be many times larger than what we have given.

However, even from this limited listing we begin to sense that these large problem-areas are system-wide, interdependent, interactive and intersensitive; that they transcend national frontiers, or even regional boundaries; and that they are seemingly immune to linear or sequential resolution.

This, in turn, suggests that when the problem-trees have grown to world-wide proportions their branches intertwine --or, if we use the image of clusters, we can say that the clusters overlap. Such areas of overlap then create new problem-areas whose description (hence our understanding of them) escapes the boundaries of the original taxonomy. Therefore, the line of approach to be taken must first aim at clarifying the systemic character of the problem-areas, and secondly, must re-state them in a way that will make their most critical synergies visible.

The five frames that will be found on the following two pages are an attempt to give a graphic portrayal of this dynamic and interactive growth of the problematique. In each of the frames the problem-areas are symbolized by differently shaped shaded spaces.

² * These Continuous Critical Problems are not listed or grouped in any particular order; nor is the list to be regarded as complete.

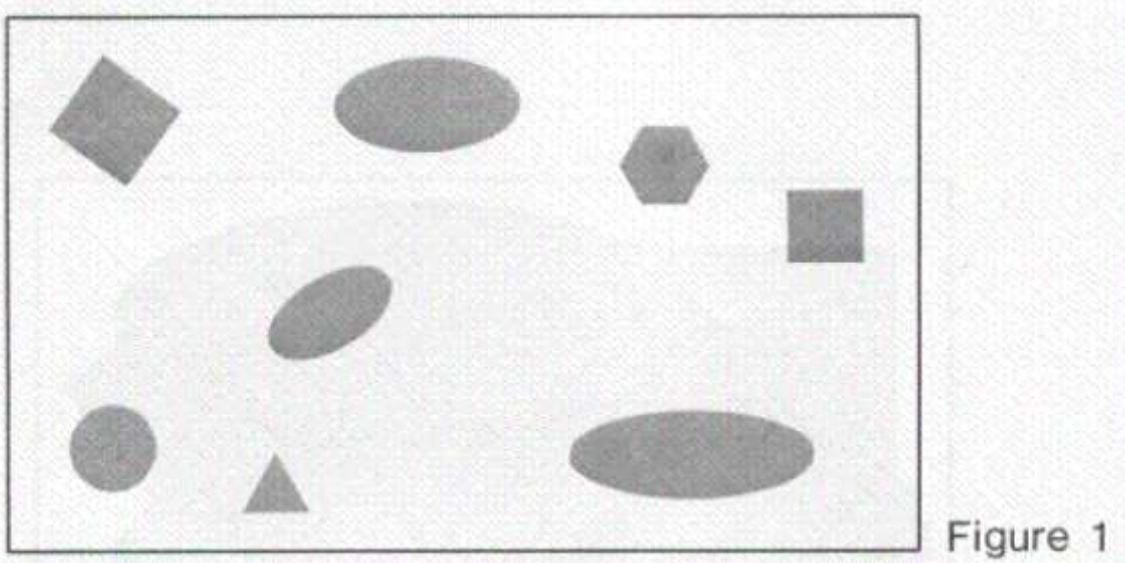
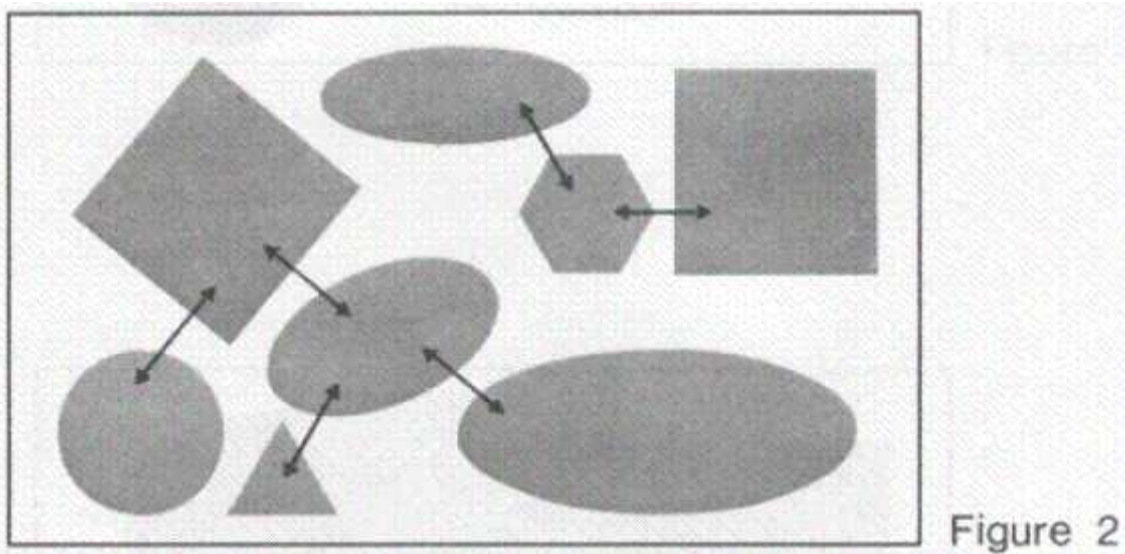

Figure 1 merely represents an arbitrary and random positioning of such problem-areas, with the aim of describing a situation wherein the visible interactions among the conjuncture of problems is patently weak or, even probably, non-existent. Such situations have often been experienced in the past especially if they were being viewed in terms of the whole world as the context within which the singular problem areas were evolving.

It is with reference to this type of situation that our problem-solving methods were developed. And they consist in attacking each of the problem-areas separately and in attempting to find discrete solutions in each such area. This analytic habit continues to hold sway over our minds, despite the fact that we have, by now, recognized the existence of certain contiguities among the problem- areas. Such contiguities have become manifest some time ago, and are no doubt due to the growth of the problems -- although this growth has displayed different rates in its momentum, and has occurred along different vectors (**Figure 2**).



The continuation of these trends would seem to have turned such contiguities into clusterings and overlaps (**Figure 3**), which we may perceive superficially but whose real structure and dynamics escape us. In actual fact the situation tends increasingly to appear as a single complex system whose internal relationships, interactions, fields of force, and overlaps are extremely confused (**Figure 4**) and impossible to delineate without a very serious attempt to model it in its entirety. Such a modeling effort could, for example, reveal the morphology of the situation as resembling what is shown in **Figure 5** -- namely, as having a composite dynamic core, and differing intensities of interfaces and relationships, all of which must be identified and organized into a unified frame of perception and understanding.

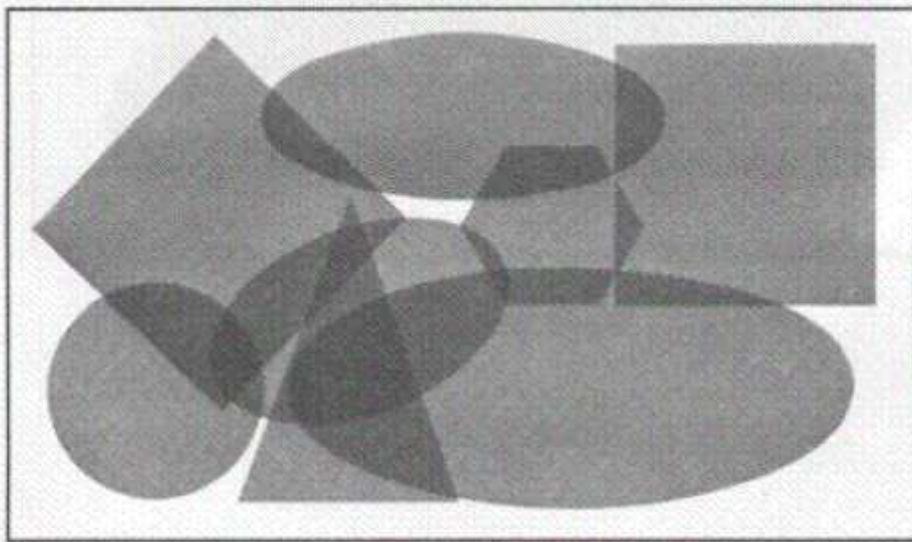

Figure 3

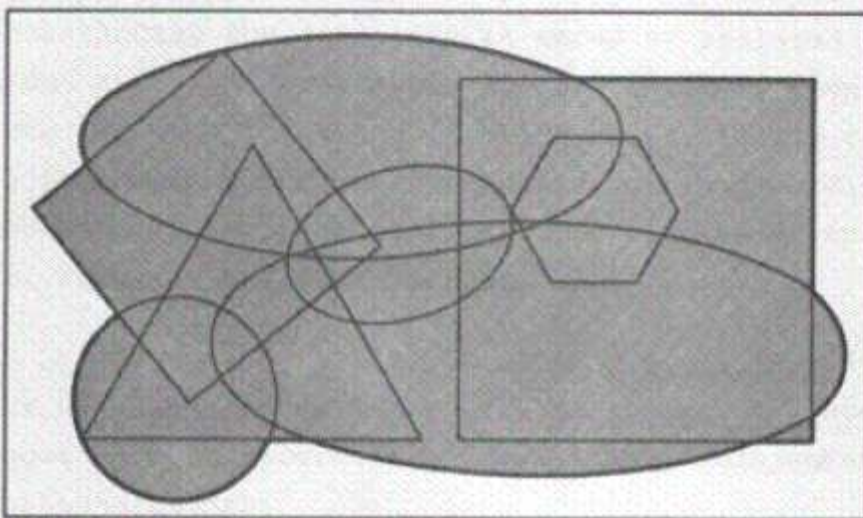

Figure 4

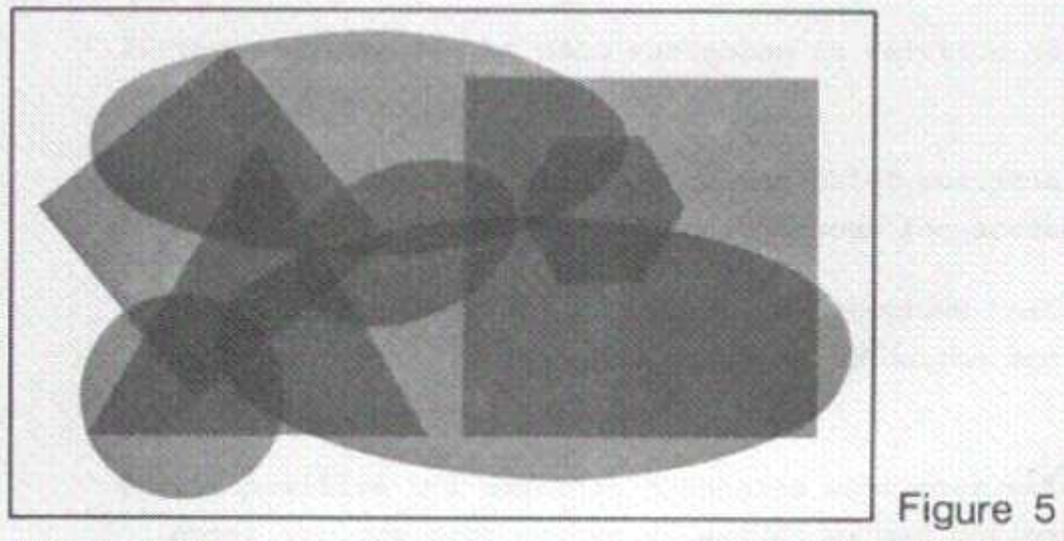

Figure 5

Such an approach -- which can only incompletely be communicated in two-dimensional drawings -- is clearly needed and clearly important for it now appears possible to surmise that attempts at understanding the situation in terms of isolated problems have gone almost as far as they can. If this be true, then, greater effort along the same lines should teach us but little that is new about the phenomena which make up the issues, and hardly anything at all about the living, changing, dynamic texture of the interconnections that actually create a "situation".

If we are to learn something new it would appear, therefore, that we need to create one or more situational models which might reveal -- with reference to, but almost independently from, the problem-clusters:

- the identity of the most critical and sensitive components of the situation;
- the main or major interactions that exist among the various variables contained in the situation;
- the behavior of the main variables in relation to within the situation;
- the time-dependent ordering of the chief possible out-comes and of their present consequences for action;
- the presently invisible critical connections that operate systemically within the present situation and that situation's future configuration;
- the positive and negative synergies that must exist among various alternative consequences and options.

Factors such as the above can be explored because, by means of modeling the situation correctly, it becomes feasible (1 to penetrate the areas of interdependence among problems and clusters of problems; (2 to manipulate the models artificially -- so as to observe the behavior of the situation's components under differently structured configurations. After the modeling work has been completed it should be possible to elaborate suggestions for curative or corrective action that might prove helpful in developing policies. However, to be taken, all these steps require that a ground be established upon which the entire modeling effort can be made to rest. Such a ground is what we shall refer to as the "value-base."

3. THE VALUE-BASE

The primary aim of modeling is to give the subject a shape, a structure, a configuration that is determined by an objective which, itself, is external to the subject. Hence the clarifications or insights that might be obtained from a successful modeling effort are never reached in terms of the subject {i.e., a problem or a situation) but in terms of the external objective to satisfy which the modeling was undertaken in the first place.

Such an objective always entails a value, and the setting of it must therefore create the particular value-base that gives meaning and direction to the whole endeavor.

A value-base explicitly stipulates certain assumptions about what is "good" and what "bad."³ In the past, it was not always necessary to make such a stipulation because a problem could be recognized clearly and singularly as a problem and therefore fell automatically into a negative value category. This is not the case nowadays when we must deal with the problematique of a whole world-wide situation. In so extended and complex a problem area the value premises reveal themselves as being so confused that it becomes imperative to define a value-base that will govern the work from the very outset.

The value-base to be selected must satisfy certain fundamental criteria. First, it must qualify as a heuristic tool-concept that can be used throughout the study. Secondly, it must be consonant with the initial perceptions and beliefs that have triggered the work. Thirdly, it must support, and in some sense justify, the outcomes that are expected from the effort. The second and third criteria have already been elaborated throughout the preceding pages; nevertheless, it might bear repeating here that the ground of pre-suppositions from which we shall start is the belief, backed by considerable empirical evidence, that there are strong interactions among the events which create our situation and that, while it is impossible fully to isolate the former, it should be feasible to identify, through modeling, some critical aspects of their temporal and spatial morphology. And, moreover, that such identification might also permit us to anticipate a number of dissonances which may not exist at present, but whose developing conjuncture could well be forming those new issues and problems which will define our future.

It is on this ground of perceived fact and belief that we must now evolve the value-base of the work, as a heuristic tool-concept that will satisfy the first criterion stated above. This can be done with reference to the nature of the problematique itself, that is, with reference to the most general attributes we find in those component elements of our situation that we have called Continuous Critical Problems. When we review these (even superficially) we find that all of them are problems in relation to something else -- either other problem-clusters or a particular state of the system in terms of which we look at them, or values we take for granted because they are embedded in our current culture. Thus, for example, uncontrolled population growth is a problem when viewed in relation to a particular state of the environment that we are now experiencing. It was not a problem when we experienced the environment differently; namely, in a different state of the overall system. Such examples can be multiplied, and if they are we shall notice that

³ This manner of proceeding is actually implicit whenever we say that something represents a "problem". When we call occurrences such as hunger, or over-population, or lack of education, "problems" we are in fact defining them in this way because according to our value system they represent a state that is bad, in comparison to an alternative possible state --which we call "solution" -- that we accept as being good.

in every instance the problematic element derives from an imbalance that affects the relationships existing among situational components.

This observation cannot but remind us directly that imbalance is a state which defines the pathology of an "ecological" system, which, in fact, our situation, seen in its entirety, represents.

Ecology, as one hardly needs to note, is the study of the equilibria and the dynamics of "populations" of living entities within given environments. The notion can be extended and generalized to comprise the equilibria and the dynamics of all entities, for every dimension of contemporary experience is a definable population of facts and concepts: biological, physiological, physical, psychological, ethical, religious, technological, economic, political, national, international, communal, attitudinal, intellectual, institutional...; the full list is no doubt finite but very long indeed. It covers everything and event among which relations of mutual determination, complementarity or competitiveness can be established.

Hence if we extend, as is increasingly being done nowadays, the definition of ecology to comprise the dimensions of occurrence in our world-wide environments it becomes possible to say that we are confronted with a problematique which is ecosystemic in character. The normative statement that describes the value- content of any ecosystem is "ecological balance." Consequently it is the idea of ecological balance that can, and will, be taken as the underlying value-base of the study; for in the terms dictated by our situation the "good" is self-evidently and most generally capable of being defined as the re- establishment of that many-dimensional dynamic balance that seems to have been lost in the modern world.

Given the general conditions of this study, such a value-base should make it possible to develop models and attain insights that have global relevance, and should further open the way for the integration of the models into one primary synthesis capable of providing ideas that, subsequently, can be made actionable in terms of concrete policies, of new structures, and new institutions.

4. CONCLUSION

The points that have just been touched upon amount to saying that: apart from the reasons of urgency for which the study is being recommended its only a priori hypotheses arise from the recognition of the problematique as possessing world-wide dimensions and therefore systemic characteristics, and that the functional attributes of today's world system necessarily involve normative elements which, being planet-wide, transcend sectoral, political, or regional differences; and the recognition that our current methods of description as well as our social and institutional structures are not designed to operate effectively in a system which is world-wide.

It should be repeated in order to emphasize the point, if for no other reason, that the approach briefly described above is non-political be it in motivation, in methodology, or in its initial results. Its aim is to create new clarificatory models of the known and already described components of our complex problematic situation so that the subsequent activity of policy formulation may be facilitated or even made possible. It represents a step forward in relation to the present state of affairs, inasmuch as the current ways of

describing our situation do not allow of any rational or effective attempt to grapple with the fundamental political considerations to which all insights and conclusions must ultimately be reduced.

V. THE PROPOSAL

The effort as a whole would be divided into two distinct steps:

First: The "project" as described herein, undertaken by the Club of Rome and dealing with the empirical aspects of the situation, its morphology and the interrelationships that operate among its components. This would be the rough modeling phase;

Second: A subsequent and more ambitious phase, hopefully to be undertaken by the World Forum, dealing with the study of the critical aggregations revealed by the initial model and would aim at the discovery of alternative means of interpreting and resolving interface imbalances and to the identification of various options that are suggestive of coordinated policies.

1. SCOPE

At the present juncture, the scope of the project (first step) is seen as follows:

- to define criteria for identifying imbalances of a global nature especially with reference to their future evolution
- to attempt a qualitative and quantitative delineation of the interactions that appear critically synergistic within the situation created by these imbalances;
- to establish a tentative morphology of problem interfaces and interactions;
- to identify and evaluate the main trends of research currently being undertaken with reference to this type of problem, to determine the degree to which such research can contribute to the investigation of the overall problematique;
- to outline programmes, initial methods of approach tasks and responsibilities pertaining to the investigation as a whole;
- to attempt to take the first steps necessary for the development of a dynamic computerized model by means of which the entire structure, rather than the mere parameters, of the situation can be manipulated, so that new configurations of the problematique may be revealed and experimented with.

2. PROGRAM

The governing statement concerning the project as a whole is that its aim is not research in the traditional sense but "invention."

This should be understood to mean that what is expected from the effort are new insights and approaches rather than the further and deeper elaboration of already known facts. The latter will be used in their present state of elaboration as the substantive material upon which the work will bear --however, the expectation that animates the work itself concerns the meaning which all these facts, in their systemic nature and system-wide impacts, have for the future of mankind.

Hence it is necessary to interpret the following program in the light of the above statement of purpose.

a) Investigation

This initial attempt should define some of the main empirical dimensions of the problematique, the way it is presently sensed and perceived.

The sources from which this information will be obtained are international agencies, research institutions, universities, special study groups, foundations, unions, associations, youth groups, and various selected interest groups, etc.

Existing data banks of national or international scope dealing with critical world problems will be located and used insofar as possible.

Nevertheless in order to avoid sliding into some form of taxonomic research activity the project will for a start concern itself mainly with the basic grouping of problematic issues that are most widely known. These were listed earlier in this document under the heading of Continuous Critical Problems.

Each of the Continuous Critical Problems that were named is today the object of more or less deep research in many organizations and in many countries. This research is generally directed toward the problems themselves and not toward their interrelations--an aspect to which particular emphasis is to be given in the proposed effort. A comprehensive survey of this ongoing research must necessarily be made in order to identify capabilities, lags, and gaps in the body of understanding and knowledge now available, and to make use of any pertinent information it affords us.

Therefore the investigatory phase will attempt primarily at infusing the Continuous Critical Problems with as great an operational meaning as feasible; to enlarge or reduce or refine the initial listing by means of trees and clusters; to establish definitions that are more precise especially in relation to the value-base of ecological balance.

b) System Description

The investigatory part of the work should lead to, or be accompanied by, the design of the system which represents the *matique* in its world-wide generality.

The organization of such a system must be so conceived as to reveal:

- the structure of the dominant interrelationships among systemic components.
- the nature and present intensity of the interactive relationships; the nature and intensity of the "feedback" and "feedforward" effects; the general (obvious) causality patterns into which the interactions can be seen.
- the dynamic of the interactions from which some idea system's future states can be sensed or deduced.
- the controlling elements of the system as it is today, and how this order is likely to change as the system evolves in time.
- the component linkages that appear to be the mostly critical.

- the functional morphology of the linkages: degrees of rigidity, flexibility, equilibrium, stability -- in the rates and the levels of the system of interactions.

The final configuration of situational components to emerge from the proposed study will therefore have a spatial and temporal morphology that embodies the dynamic process that animates critical world problems, when that process is set in the context of a general value framework of ecological balance.

The project will not attempt a forecast of how problems will be apprehended in the future, although the final shape of the system will depend on the integration of alternative perceptions of the future with perceptions that have currency today.

c) Report

The project should result in either one or several reports containing the synthesis of the work conducted, interpreting the new system of world-wide critical interconnections, the key problem-clusters that should be given particular attention, and the methods to be used in their further investigation.

d) Outcome

The reports, by giving a clearer picture of the nature of the problematic interactions, of their relative importance and their dynamic configurations, should be of use as a preliminary indication of possible new and viable directions in the field of policy-making.

Once this initial aim is attained it is the hope of the Club of Rome to have its findings reinterpreted in depth by the kind of instrumentality that was referred to earlier as the World Forum. Such reinterpretation would allow the results of the project to be fitted into the framework of different value systems and molded into new attitudes and outlooks at a higher level of political endeavor where new structures and institutions can be designed. However, to be reached, these ends require means that are both more ambitious and more sophisticated than those to be used in the project --e.g., policy analyses and design, trade-off calculations, deontic logic applications, the construction of alternative systems, long-term dynamic simulations with multiple variables, etc.

Through such means a normative as well as an empirical delineation of the future states of the world system might be obtained together with the details of the new framework of integrated policies, institutions, and organizations that are necessary to render such a new world system operational.

e) Organization

The overall organization of the project is described below in its relationship to the envisaged structure of the Club of Rome.

A. The aims of the Club of Rome have already been noted in relation to the project being considered here. Its general objectives and constitution are described in Section Three (Annex I).

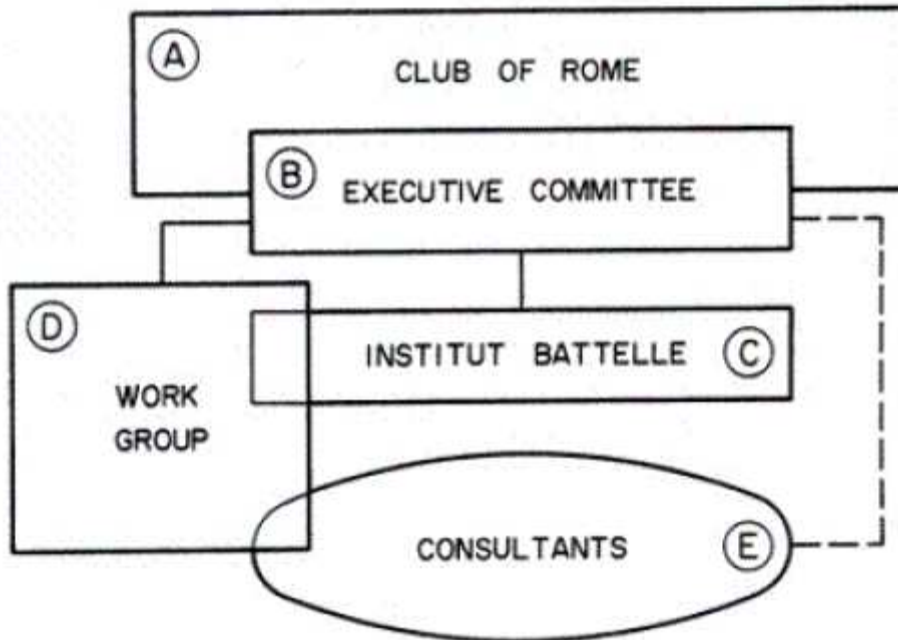

B. The project falls directly under the cognizance of the Executive Committee of the Club of Rome. During the latter's formative stage an Executive Committee has been formed ad hoc whose membership will be found in Section Three (Annex III).

C. The Executive Committee has asked the Institute Battelle at Geneva to provide administrative support and act as managing agency for the project. This request having received favorable response from the Battelle management, it was decided that Battelle's Geneva Centre de Recherche would be providing hospitality and facilities for the Work Group that will be engaged in carrying out the project.

D. **The Executive Committee has asked Prof. Hasan Özbekhan to undertake the overall direction of the project and the operational responsibility for the Work Group.** Currently, the Work Group itself is visualized as consisting of some ten senior scientists from various national backgrounds, supported by a team of junior researchers. Further details concerning the Work Group will be found in Section Three (Annex IV).

E. The aid of a number of Consultants will be solicited to support the Director of the project. These consultants should be authorities in various fields that pertain to the project in its generality.

The principal role of the consultants will be to offer new ideas and substantive verification from the viewpoint of disciplinary approaches whenever necessary. A general idea of the planned competence of this consulting group will be found in Section Three (Annex V).

3. COST AND DURATION

It is expected that the project as described can be realized within a budget of \$900,000 and that its duration would be approximately of 15 months. Therefore if the work can be started sometime during the summer of 1970 it should be completed by the end of 1971.

SECTION TWO: Conceptual Frame and Work Procedures

INTRODUCTION

1. THE CONCEPTUAL FRAMEWORK

The purpose of the present section is to provide an overall impression of how the work described heretofore might be conducted, and to discuss insofar as is possible at this early stage some methods and techniques of approach that are tentatively being considered.

No firm and unequivocal commitment to a given methodology can be made at this time. The problematique -- i.e., the subject to be addressed -- that was outlined is extremely complex and must be approached by way of a unifying framework of concepts that will afford it a solid methodological basis. The chosen approach itself needs in some sense to be an invention closely and specifically tailored to fit the needs of the subject.

Viewed in this light, it becomes evident that the work must be conducted not merely as if it were a straightforward investigation into known facts but rather as an effort (1) to uncover new meanings and consequence-patterns that inhere in dynamic combinations of such facts, and (2) to shape such meanings and consequence-patterns into new, more revealing configurations.

To do this we need to meld together two fundamental, but different, logical approaches:

- a hypothetical-deductive system that provides us with the tool concepts necessary to penetrate and manipulate the facts that make up the situation surrounding us;
- a cybernetic system by means of which we can create alternative configurations of our findings, both so as to make the latter clearer and to see the various behaviors of newly defined consequences within different time frames.

This is to say that we must on the one hand build an axiomatic, and on the other hand a plan.

Through the melding of these two approaches, it should be feasible to examine our world-wide situation and to develop some ideas about how it can, or ought to be changed, to accord with the value-base of "ecological balance" that we have chosen as the ground of our reasoning.

We should note moreover that to create such a combined system of methods we have to take into consideration the levels of cognition from which the problematique and its

components are perceived. Hence the Work Group (and what it represents, namely, the Club of Rome) will enter strongly into the methodological equation because its perceptions will be governing the work.

Having made these basic clarifications we may begin by establishing some procedural assumptions. In doing this we shall alter the order of the above, to basic approaches and begin with a tentative outline of the cybernetic system so that our thoughts can be organized in a logical manner.

2. TENTATIVE PLANNING CONSTRUCT

A. WORKING ASSUMPTIONS

In our attempt to design an initial and highly tentative planning construct, we must begin by proposing certain definitions that can also be considered as working assumptions.*⁴

CONCEPTS	DEFINITIONS
PROJECT	Substantive operations undertaken by the Work Group
GOAL	Results expected from the project; i.e., suggestions, clarifications, insights, reports, impacts.
OBJECTIVE	Directives concerning the goal that the Work Group receives from the Club of Rome.
MEANS	Instrumental inputs that the Work Group receives from or through the Club of Rome, including information techniques, methodologies, ideas, facilities, etc.
EVENTS	Subject of the work; i.e., elements or components of the problematique

TABLE I

Among the foregoing concepts, the ones listed below are operational variables that enter into the overall framework as follows :

CONCEPTS	DEFINITIONS
GOAL	Output
OBJECTIVE	Controlled inputs
MEANS	Controlled inputs
EVENTS	Uncontrolled inputs

TABLE II

⁴ * The ideas that will be found throughout this whole section derive from many sources and represent a synthesis of the thoughts of many authors. Unfortunately neither the nature of the document nor the circumstances in which it was written permit individual recognition with respect to every point made.

The most simplified and elementary way of visualizing the relationships that will become established among these elements in the course of the work, is shown (Fig. I) on the next page.

It is self-evident that the nature as well as the level of the output are entirely dependent on the nature and the level of the relations we can establish and formulate with regard to the inputs that will enter the system of work. Moreover, these relations are likely to give us some indications of the methods of approach, which might have to be used. Hence the assumptions we have advanced will now have to be looked into somewhat more closely.

B. CONTROLLED INPUTS

The controlled inputs we have defined are objective and means. The precise operational meaning of these words as well as the manner in which they interact in relation to the goal must be determined.

Here, the first point to be made is that neither the objective nor the means are fixed or static concepts. They constantly interact with each other, with the project -- that is, the work-in-progress -- and with the subject of the work, namely, the event.

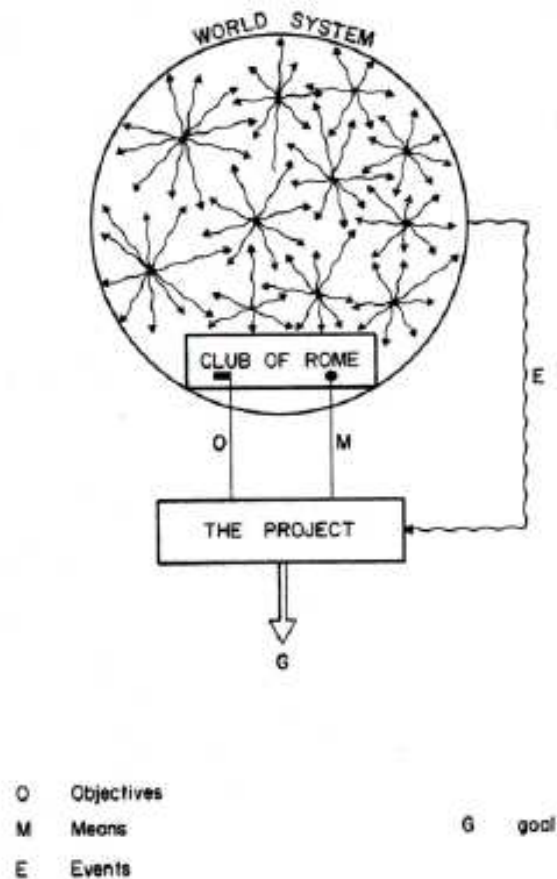

Fig. I

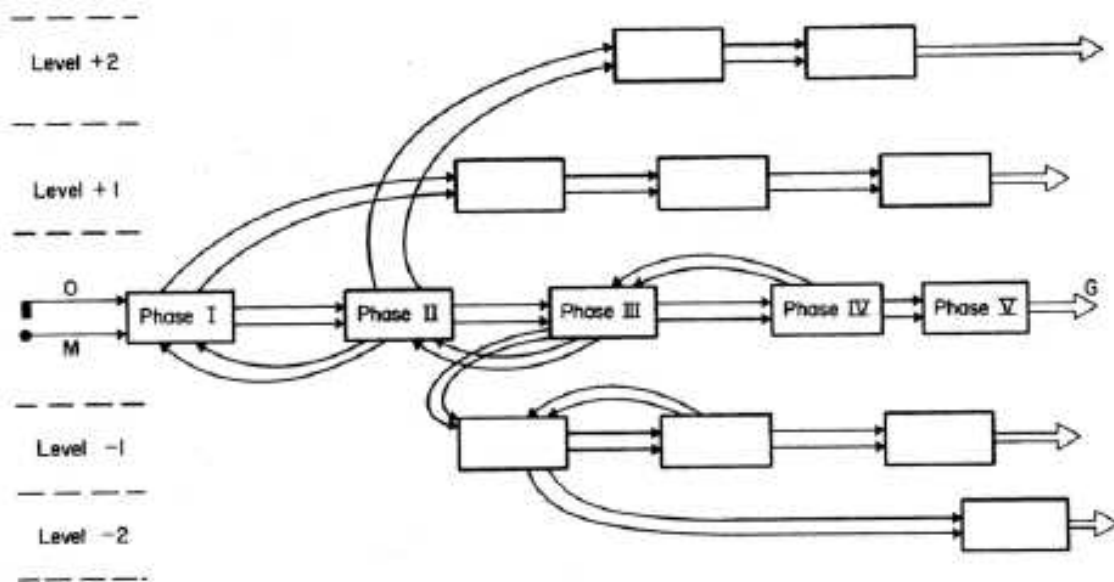

Fig. 2

This interaction need not necessarily alter the direction of the objective (i.e., the nature of the task) or the nature or quantity of the means. But it is very likely to cause changes in the level of goal-attainment.

This is because the time-span of the work envisaged is something in the order of fifteen months and a learning process will set in as soon as it starts. This, in turn, will alter the perceptual make-up of the Working Group. This process can be outlined as shown on the following page (Fig. 2).

There are further reasons, connected with but differing from the learning process, that force us to consider those differences in level that define a relationship of dependency between output and controlled inputs. This introduces two ideas that are fundamental both methodologically and substantively.

These ideas are:

- "Futurity" or the future dimensions of the events that form the problematique to be investigated; and
- "normative analysis" in the light of which the value-base that was chosen --i.e., ecological balance --can be made to govern the objective of the work.

The notion of futurity enters into the argument because there are basically two ways of looking at a situation and perceiving its problematic features. Both are grounded in the idea of "differential". Namely: (a) a situation represents a problematique because some of its characteristics differ from the characteristics of a past situation that the people involved agree to define as non-problematic --or as "normal"; and, (b) a situation represents a problematique because some of its characteristics differ from the

characteristics of a future situation that the people involved agree to define as non-problematic --or as "ideal".

In either case the first step is to proceed from a general, agreed upon, image. And, in either case, what makes agreement possible is a shared value-base.

In the project being considered we have started from the assumption that the problematique is both world-wide*⁵ and new in its configuration; therefore it would be impossible to evaluate its differentiating aspects with reference to a past situation. Hence it was decided to establish differentials with reference to some future state of the world-system of which the defining value-base would be "ecological balance".

To be able to create such an image two things are necessary:

- an idea or vision of how events will evolve toward the present situation is left to itself or left to evolve with a minimum of tampering;
- an idea or vision of how the situation will look in the same future if it is normatively conceived in the light of ecological balance.

It might or might not have been noticed that in the foregoing few paragraphs the whole argument was given a somewhat new shape merely by elaborating in a very superficial way various points that are embedded both in the facts we must deal with and in the general methodological philosophy we have adopted at least for a start. Thus we have:

1. **OUTCOME PARAMETERS:** in the sense that the goal must deal with "differentials" between a present state of the system and a future state of the system.
2. **INPUT PARAMETERS:** in the sense that the objectives and means must be set at such a level so as to permit:
 - 2.1.1. A forecast of the normal future state of the present situation (logical future).
 - 2.1.2. An image of the future state as can be imagined in the light of the value-base of ecological balance (normative future).
 - 2.1.3. Interim states of the objective for judging whether the difference between 2.2. and 2.3. adds up to a meaningful evolutionary or interim situation be identified and singled out.
3. **THEORETICAL FRAMEWORK:** which is the value-base (ecological balance) that must be so clearly and operationally defined that it can be used to judge any established relationships as valid or invalid.

From these points certain new conceptions regarding the level of dependence problem can be derived. For example, and solely as an example, we can establish the following levels:

⁵ * This feature alone would make it impossible to judge it in terms of a shared past value-base.

Levels	Output	Controlled Inputs		Uncontrolled Inputs	
	Goals	Objectives	Means	EVENTS	
				Forecast	Normative
Null	g Ø	o Ø	m Ø	e Ø	E Ø
Low	g 1	o 1	m 1	e 1	E 1
High	g 2	o 2	m 2	e 2	E 2
Ideal	g 3	o 3	m 3	e 3	E 3

TABLE III

From an arrangement of this sort it becomes -- or should become -- possible to build various models (which, basically, are pay-off matrices) in which the combined weights of objectives and means can be made to relate to various levels of forecast and normatively determined future events to derive different levels of goals.

It is in turn from such models that corresponding plans will be constructed in which all the concepts that were listed earlier (Table II) can be related to each other in a way that is not arbitrary but optimizing.

The most important consideration in the structuring of controlled inputs is the definition of "ecological balance", which needs to be established as the governing principle of the objective. Such a definition does not exist at present nor can the idea itself be given any kind of operational meaning through mere verbalization --namely, through a simple description of what the expression might signify.

"Ecology", that is human ecology in the sense we have described it in the first section of this document is, itself, a system of extraordinary complexity comprising both individual entities and multidimensional relationships, some of which have network characteristics. All the component forces and phenomena existing in such an ecology cannot be taken into consideration in a study such as the one being envisaged. Nevertheless a series of them that pertain with particular emphasis to those elements problematic that will be studied has to be selected and developed into indices, in accordance with the best methods extant for the creation of such indicator lists . It is possible that certain interesting ideas being explored in the USA as part of the effort involved in creating Social Indicators might prove useful, in building such lists.

In conjunction with this, simultaneously in fact, the notion of "balance" will have to be reduced to operational significance. Balance, in a system-wide human environment, is ultimately reducible to a finite number of trade-offs . Hence what will be required to make our objective operational is, in all probability, a three-dimensional matrix in which the selected ecological indicators are ascribed trade-off values not only in terms of monetary cost but also of other vital kinds of "costs" and kinds of "worth" pertaining to action and outcome (i.e., to policies and results).

With such indices and matrices at hand it should become increasingly feasible to view the model of a problematic situation in the relatively simple form

$$W = f (I_i , O_i)$$

where

W = the measure of the worth of a particular action (or policy).

I_i = the input variables that control the alternative courses of action.

O_i = the extraneous, non-controlled variables, that affect action*⁶.

Aside from level relations and adjustments and indices that lend operationality to the objective, the legitimacy of the plan must also derive from its dynamic conception -- namely, from the manner in which the foregoing ~ through the system as a whole. For it is evident that the relationships among all operational elements will be constantly changing. Hence it is important to develop from the outset a planning construct that recognizes and accommodates such changes while the work is going on. The rationale for this is that the Club of Rome is not external to the world. It too is part of the situation. Therefore, it follows that ~ inputs must, themselves, be viewed as feeding into the subject of the work.

Since the subject of the work is in a state of continual flux, the work must necessarily be evolutionary and dynamic. Some results, representing clarifications of the problematique's components, will be obtained as the work process unfolds. In consequence it is likely that:

(1) a feedback loop will be generated going from these continuous interim results back to the Work Group, and change the perception of the latter with regard to the interpretation of the objectives to be attained;

(2) another feedback loop generated by such results will affect the notions that the Work Group has concerning the nature of the output --i.e., the goal. These shifts, or renewals, in understanding may change the perception of the Club of Rome concerning the problematique and must therefore be viewed as a source of new objectives as well as of new means --i.e., of new controlled inputs.*⁷

All these feedbacks whether taken singly or in combination will affect the nature of the output and possibly alter it.

Recognition of these processes provides us with a preliminary planning construct which is outlined on the next page (Fig. 3).

Up to this point we have dealt mainly with the controlled inputs side of the overall work plan. In the following pages we shall deal with questions concerning uncontrolled inputs.

⁶ * This general formulation of action variables within the context of an entire system was developed by Dr. A.N. Christakis and Dr. N. M. Kamrany.

⁷ *Moreover if such results are very important and dramatic (which is unlikely) they will also create a feedback loop into the situation and generate new events. But because the probability of this is very low it need not be considered presently. (That is the reason for that loop being shown in broken lines in the figure on the next page.)

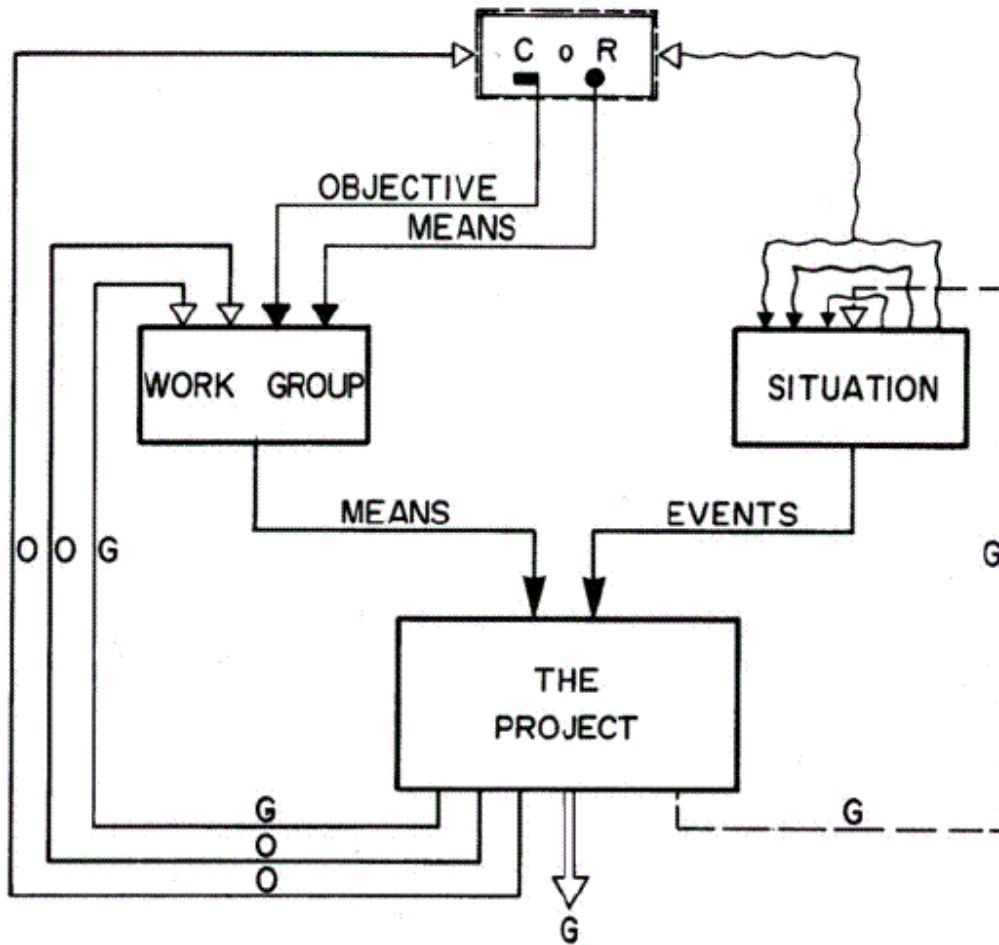

Fig. 3

C. UNCONTROLLED INPUTS

The uncontrolled inputs with which we shall concern ourselves have been qualified as "events". Events are the substantive elements of the situation; therefore, they describe all the components of the problematique including what we have called the Continuous Critical Problems.

The controlling issue with reference to events --insofar as the proposed study is concerned --is that they must be understood in their essence, in their structure, and in their dynamic behavior. Hence our approach to them must be hypothetical- deductive in character; and our aim, the creation of an axiomatic.

This is obviously very difficult because today the configurations of the very important events that are constantly occurring around us are blurred. We have no precise feelings concerning their nature, no real way of formulating ideas about their future implications, no appropriate methods to trace the causal connections between what we sense to be symptoms and what might be the central illness. Linkages that were clear when our minds operated within the framework of determinism have become obscured and

confused. Empirically we are able to describe numerous problems -- but this approach does not really help us to penetrate the essence of the situation. What seems needed is to proceed, mainly, through heuristic, inventive approaches, using almost any technique in the hope that we might sufficiently disarrange what is obvious so as to be able to penetrate a little further into what might be real.

Once these facts have been clearly recognized and admitted we can start by establishing a number of hypotheses, which will underlie as well as guide the study. These hypotheses obviously derive from many sources and represent a particular manner of cognizing the nature of the reality that surrounds us --they are, nevertheless, consonant with the value-base of ecological balance we have chosen as the governing objective of the study.

1. The events to be considered are crisis-related components of our situation.
2. In their totality these events represent a problematique . Problematique is not defined by its component events as an aggregation that is analogous to a "set" --in the mathematical meaning of the term --but as a system.
3. As such, the events to be studied are in themselves and in their attributes, dynamic, interconnected, and interdependent and that "operate together ...in such a way as to produce some characteristic total effect".*⁸
4. These dynamic relationships do not appear to be either regular or stable; they are akin rather to evolutionary "jumps" that create imbalances throughout the system.
5. Such imbalances seem to have two major characteristics: (a) their time-scale of occurrence is relatively short and might be getting shorter; (b) they are, or appear to be, a-causal inasmuch as each imbalance has impacts that resonate throughout the system, although in varying degrees of intensity. These characteristics will have to be operationally probed in terms of the fundamental criteria that apply to ecosystems:

Temporality	Complementarity
Spatiality	Mutual-determination
Quality	Competitiveness
Quantity	Synergy

⁸ * In this hypothesis the definitions of Hall and Fagen and that of Allport have been paraphrased somewhat and combined. See: A.D. Hall and R.E. Fagen.. "Definition of System" in Modern Systems Research for the Behavioral Scientist, WW. Buckley (ed.) Aldine Publishing Co., Chicago, 1968. And, F.H. Allport, Theories Of Perception and the Concept of Structure, John Wiley and Sons, New York 1955.

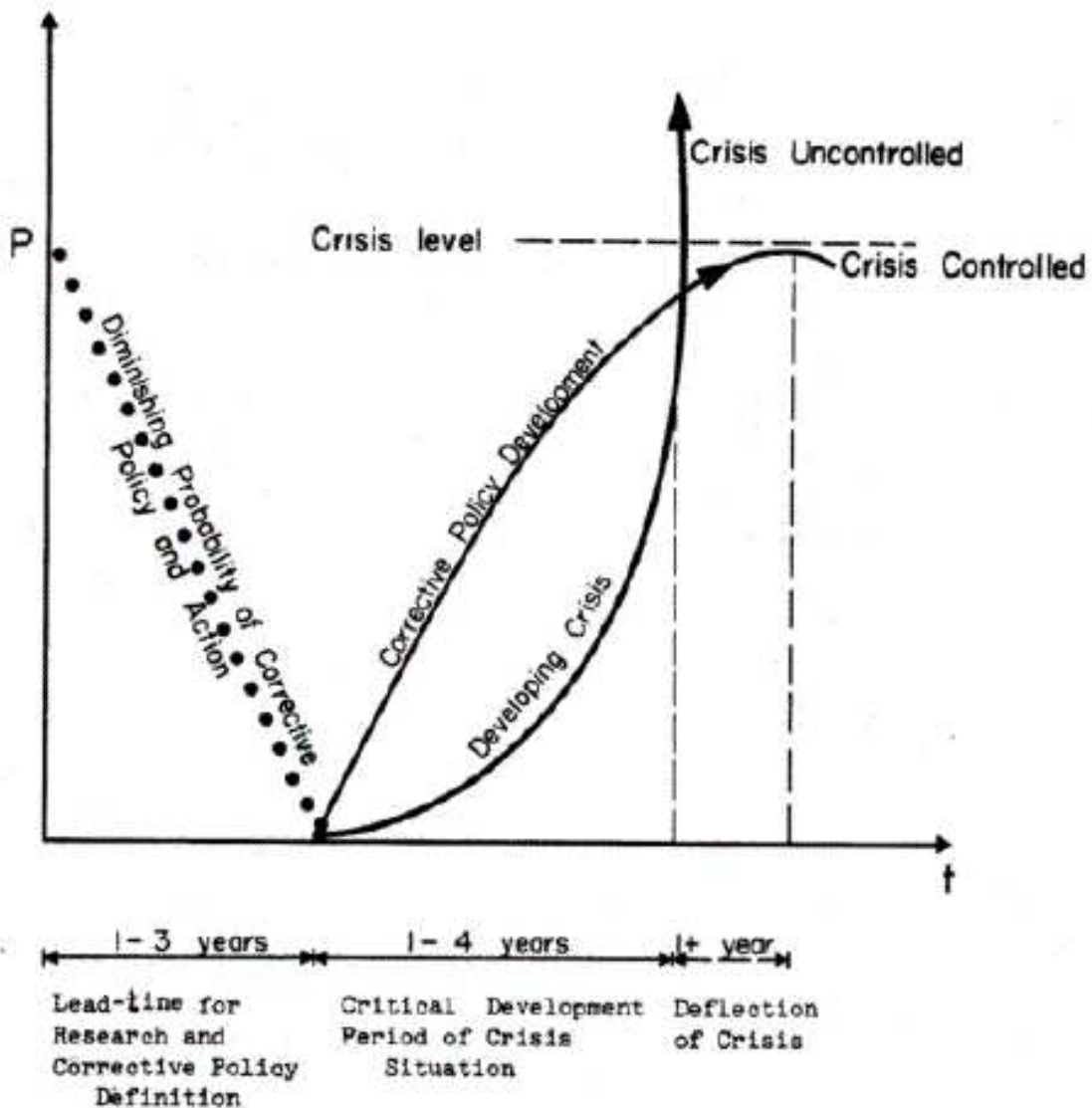

Fig. 4

Note: We shall assume in the study that critical events behave approximately as shown above. Namely, there is a crisis level at about 4 years hence beyond which most of the events we must consider will become uncontrollable, unless they have been deflected by newly developed corrective policies. The deflection period must be conceived as short to be effective (1+year). The lead-time for projects such as the present is generally set to 1-3 years. These figures represent an averaged-out consensus of those working in Crisis Research in the USA. They were obtained from Dr. John Platt of the University of Michigan at Ann Arbor.

6. This might suggest the presence of various kinds of impingement effects within the system that generate new events. These effects could be phenomena like: interface, mismatches, intersensitivity, clusterings, overlaps, synergies, functional dissonances, time-phase dissonances, etc.

It is in terms of these six basic hypotheses that the study will be conducted. The main thrust of the effort will be directed at identifying:

- 1- The "events" within the system --namely, the components of the problematique.
- 2- The "attributes" of the events --namely, the components' functional characteristics.
- 3- The "relationships", "interconnections", and "interdependencies" among the events and among their attributes.
- 4- The "characteristics total effect" that results from all the above and that we have called the "situation".

In the course of the project the greatest emphasis will be given to the first three points noted above, whereas point four is to be viewed as the subject of later efforts that have been mentioned in the opening section of this document.

III. GENERAL COMMENTS ON METHODOLOGY

It is not possible to delve deeply into the methodologies to be used in this project because:

- a priori decisions about methodology might prejudice the outlook of the Work Group to a degree that would reduce its effort to an arbitrarily slanted, academic exercise ;
- although there are a number of methodological approaches that have been evolved in recent years all of them, almost without exception, are still highly experimental --so that it is impossible to judge their operational worth especially in relation to a large-scale problematique such as the one we shall have to consider.

In the light of the above the best strategy would seem to be that of remaining free of methodological commitments and pre- conceptions and to choose the apposite approaches as we go along and as the work dictates.

This obviously does not mean that the effort will be entered into blindly. On the contrary, it means the circumstances are such that the greatest freedom of action and flexibility of invention must be preserved. The specific methodological field within which we shall be able to make the needed choices is large, but it can be described if we outline the project's operational evolution, as is done in the flow chart (Fig. 5) on the following page.

This chart shows the step-by-step development of the project starting with the given value-base that leads on the one hand to the creation of a normative image of the future and on the other hand to the setting of the correct objective/means level. From this ground (which satisfies the normative and some of the strategic requirements to start the work) the project proceeds to the identification of "events", namely, the uncontrolled inputs, and advances through self-evident logical steps to the goal.

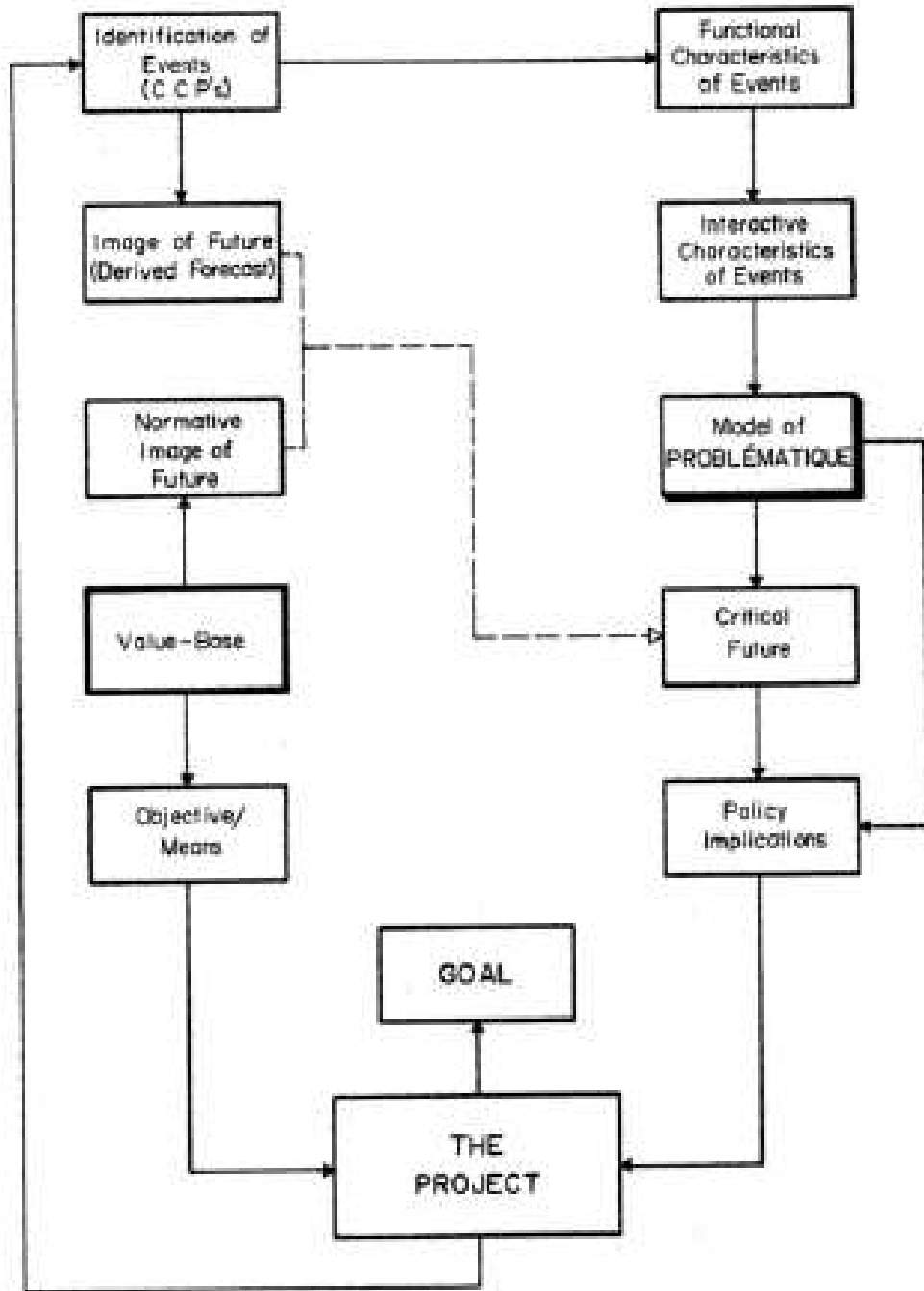

Fig. 5

Each of these steps will require one or more methods or methodological approaches. Decisions with regard to such approaches will have to be made in the course of the work. There are, in fact, several levels of methodology that will have to be closely considered at each stage. A number of these are shown, by way of example and illustration (in Table IV on the page 58) as they pertain to the work in process when such work is broken down into the three fundamental planning categories which are: the Normative, the Strategic/and the Operational.

As a final comment on the contents of the preceding table it might bear repeating that the methods which will be used for advancing the work as a whole are not yet fully known. Their elaboration is itself a part of the project. For instance, it is felt intuitively that many developments in cybernetic logic, in multi-valued logic, in generalized logic, in meta-ethics, in economic analysis, in coding, in structural morphology, in biotechnics/and in many other areas of knowledge have a great deal of relevance for the effort as a whole. Naturally, they will be introduced into the work process whenever a need for them becomes manifest. Moreover, the present feeling is that no single method or technique will suffice for the purpose before us. Hence combinations that are heuristically conceived will have to be created almost constantly, and experimented with. This applies to the methodologies we have noted as well as to those we have not. All these points are made once more to underline as clearly as feasible that the project as a whole is one of invention and that whatever comes to hand to advance it --with the requisite intellectual validity and honesty --will be used, by itself, in combination, or with appropriate modifications.

IV. MODEL OF WORK PROCESS AS PRESENTLY ENVISAGED

Having outlined the manner in which at present we intend to deal with controlled and uncontrolled inputs that are part of the structure of the project as well as work process, we can now complete the model that is descriptive of the whole insofar as we are able to visualize it at this time.

This model is envisioned as a rather simple cybernetic system in which the types of inputs we have discussed are transformed into outputs that are consonant with the objectives of the Club of Rome, as these objectives were set down in the first section of this document.

Our views of the overall work process are now much clearer, as can be seen in the general model provided on the next page (Fig.6). Into this model we have further introduced an indication of our expectations beyond the execution of the project itself. This was done solely to show how the total idea that inspired the Club of Rome might be viewed in its unfolding during and after the assumed successful conclusion of this particular project. It is in this sense that the prospective possibilities shown below the broken line that divides the diagram ought to be interpreted.

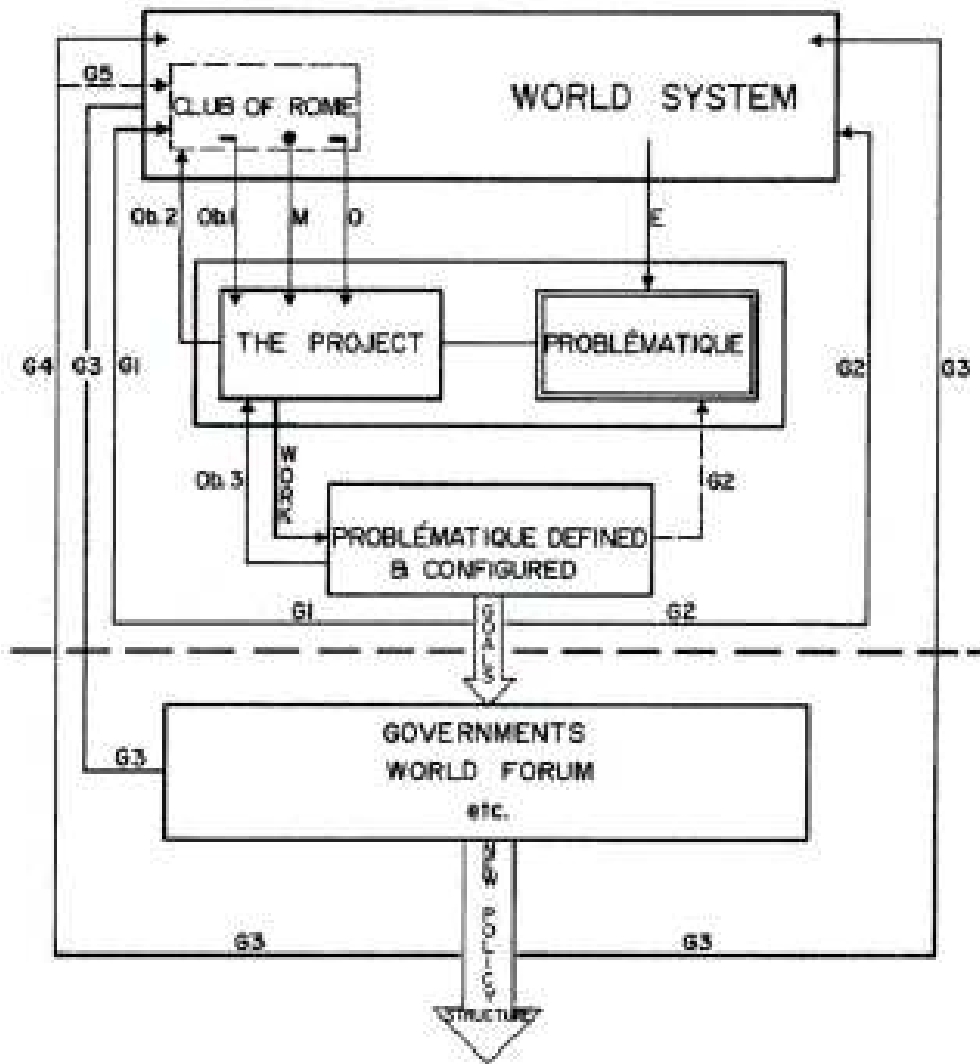

Fig. 6

- Ob. 1. The prime objectives ascribed to the project by the Club of Rome.
- Ob. 2 First changes in Ob. 1 as a result of interim findings by the Work Group.
- Ob. 3 Final changes in Ob. 1 as a result of the definition and configuration of the Problematique.

Changes in Ob. 1, Ob. 2, Ob. 3 result in firm objectives (O) and required means (M).

M Means provided by the Club of Rome to the Project.

E Situation existing in world system as perceived by Project.

E The uncontrolled inputs from the Problematique on which Project will work.

E Adjustments in the perception of the Problematique as a result of its definition and configuration.

Goals Expected outputs from the definition and configuration of the Problematique.

G.1 Changes affecting perception of the Club of Rome in expected outputs as a result of interim attainment of Goals. These will be expressed in the new formulation of firm objectives (O) and required Means (M).

G.2 Minor possible impacts of interim outputs on World System -- affecting E and El.

G.3 If World Forum materializes and continues work; new perceptions will be fed into World System.

G.4 If the work of the World Forum results in new policy structures, World System will be affected.

G.5 Similarly perceptions of the Club of Rome will change.

G.3 and G.4 are viewed as the major "change" agents.

SECTION THREE: Annexes

ANNEX I: The Club of Rome

The Club of Rome was started following a meeting convened in Rome in April 1968 by the Giovanni Agnelli Foundation and the National Academy of Lincei to discuss new approaches to the problems of world society. At the end of this meeting a number of those present, increasingly concerned about the symptoms of breakdown of our society that are appearing simultaneously with higher levels of prosperity and the ever-quickenning application of new technology, decided to continue to work together, and called their group "The Club of Rome" after the city of its origin.

The Club of Rome is an informal, multinational, non-political group of scientists, economists, planners, educators, and business leaders. It is non-political in the sense that its members are not involved in current political decisions and that it has not itself any ideological or national political commitments. Its vocation is the good of mankind -- which in its opinion subsumes also the good of any nation or people in a world that is rapidly emerging as a whole, integrated system. It believes that a rethinking, rediscovery, and reformulation of values consonant with the realities of our time is needed; that broad goals for man and society must be defined; that a new set of institutions and instrumentalities is required to conduct human affairs adequately; and that to organize human society at this higher level we must first understand the present exceptionally dynamic and dangerous world situation and the kind of futures that may eventuate from it. Its overall objectives were thus formulated as follows:

- "(a) To contribute toward an understanding of the problems of modern society considered as an ensemble, and to the analysis of the dynamics, interdependencies, interactions, and overlappings that characterize this ensemble, concentrating particularly on those aspects that concern all or large sections of mankind;

- “(b) To heighten the awareness that this complex of tangled, changing, and difficult problems constitutes, over and above all political, racial or economic frontiers, an unprecedented threat to all peoples, and must therefore be attacked by the multinational and transnational mobilizing of human and material resources;
- “(c) To make the results of these studies and reflections known to public opinion, in scientific, intellectual, and political circles, and to centers of decision at all levels, in order to influence to the utmost extent the conduct of the world's affairs in a more rational and human way.”

To carry out this design, the Club of Rome has to spread its action in various directions, including the carrying out of studies and research as indicated in the present Proposal. So far, it has established a number of contacts with key people in Ottawa, Moscow, Washington, Tokyo, Buenos Aires, Stockholm, Berne, Vienna, and other capitals, as well as in international organizations; and it is expected that this activity will be continued also during the execution of the project herein.

The Club of Rome was incorporated on March 1970 in Geneva as a non-profit private association under the Swiss Civil Code. Its Secretariat is in Rome; and representatives or offices will be established in various parts of the world, the first two being in Geneva c/o the Institut Battelle and in Tokyo c/o the Japan Techno-Economics Society. By its Statutes, its membership is limited. At present, there are (25) ordinary members and the total number envisaged is 60. New members are co-opted with the approval of the Executive Committee.

ANNEX II: The Idea of a World Forum

The present project, as emphasized in the proposal, constitutes but a stepping stone which, it is hoped, will lead to further, more elaborate, in-depth studies based on the preliminary morphology of the problematique that the project will endeavor to construct. These in-depth studies cannot be attempted within the framework of the Club of Rome. Such an undertaking requires anew form of cooperative effort among industrialized countries. The Club of Rome tentatively advances the idea of a World Forum as the under-pinning of this effort. This idea should not be understood as a rigid, fixed, or sine qua non prescript for future effort, but as the subjective formulation of what the Club of Rome feels would be an adequate framework for a profound and action-oriented study of the predicament of mankind.

As envisaged, the World Forum would be created by the governments of industrialized countries through an act of political will. The direct involvement and responsibility of governments in this venture seems essential, for policy challenges of a world-wide nature can no longer be met unless they are integrated with policy considerations of a regional or national character. The Club of Rome recognizes that one of its basic tasks is to act as a catalyst in bringing about such acts of political will. To this end, contacts have been made with international organizations as well as with governments whose positive responses are considered vital to the initiation and the carrying out of a study program under the aegis of a World Forum. The Club of Rome has also accepted as its responsibility the need to provide a rationale for structuring the work of the World

Forum, and to offer it a suitable body of methodology as well as tentative models of mankind's dynamic but unstable situation. It is to meet this particular responsibility that the accompanying project has been proposed.

The conception of a World Forum cannot be elaborated in full detail at this juncture. That would be the initial task of those governments who engage jointly in the effort to create such a Forum. However, in line with current thinking in the Club of Rome, the World Forum might be conceived as an ad hoc organization, separate from any other agency and established with the sole purpose of executing in-depth studies of the various critical aspects of the human situation. It should be kept slim, flexible, and adaptive to changing needs. It is likely that the period of its duration should be limited, say from three to five years.

Since it is hardly possible that the necessary scientific brain-power could be marshaled and shaped into inter-disciplinary teams for a temporary assignment of such magnitude, it would be more feasible to set up an effective method of organizing and managing inputs that could be obtained mainly from the intellectual resources now available in "think groups", consulting firms, research institutes, academic institutions, industry, etc.

A three-fold multi-national organization might be envisioned that would consist of:

- An International Board of perhaps 10 to 12 members of the highest international repute to work full-time at the of the World Forum, aided by a small administrative staff.
- A flexible arrangement of scientific panels and workshops, to guide the work of the various groups undertaking differing but consistent patterns of individual study, and to provide the "fine-structure" of the rationale; such scientific panels and workshops might operate in an intermittent way and convene at the seat of the World
- Forum or elsewhere according to need; members would be selected from scientists of renown who would be able to devote a large fraction of their energy and time to this task;
- A flexible group of external contractors, ranging from individual experts to large inter-disciplinary research institutes and academic centers, to whom specific tasks would be assigned.

The thrust of the World Forum study would be directed to creating the elements of a world policy and to devising means for its subsequent enactment in the form of new, world institutions and their corresponding instrumentalities. The working out of operational plans having world scope might hopefully follow. However, the principal goal of the World Forum study, as the Club of Rome sees it, would be to convey to policy-makers and to the public at large a dramatic "state-of-the-world" message supported by proposed policy responses. In other words, it would serve to clarify our fears and give focus and direction to our hopes. This might in turn give rise to a massive public *prise de conscience* that would pave the way to action by enlightened governments and world leaders.

ANNEX III: The Executive Committee

The Executive Committee is in the process of being formed, hence a listing of its members cannot be given at this time. Such a listing will be communicated to the full membership of the Club of Rome as soon as possible.

ANNEX IV: The Work Group

It is tentatively felt at this juncture that the effort described in this document will require a Work Group of Senior Scientists and a Support Team of Junior Researchers.

The competences envisaged as necessary are the following:

- -1 project director
- -3 planners with general system analysis and cybernetics backgrounds
- -1 mathematician specialized in topology
- -1 senior statistician with operations research background
- -2 senior computer programmers
- -1 social scientist with experience in morphological analysis
- -1 economist with knowledge of general systems theory
- -1 political scientist with experience in international relations.

The team of junior researchers will come mainly from the areas of computer programming, logic systems, data retrieval, file composition, formatting, etc. It is also one of the aims of the Club of Rome that through exposure to work with the main task force, the team of junior researchers will undergo an intense educational and formative experience.

It is expected that the work can easily be handled by available computer capacity, i.e. Honeywell 632 (Battelle) or CDC 3800 (Geneva University).

ANNEX V: Consultants

It is deemed to be of the greatest importance that a strong roster of Consultants be created to support the Work Group during the course of the project.

At this stage two categories of consultants are being contemplated:

- Specific individuals capable of providing knowledge and skills in various disciplines such as, for instance: Political Science, Law, Economics, Sociology, the Hard Sciences, Life Sciences, Ethics, Anthropology, Psychology, Education, etc.
- World leaders in various cultural fields --Religion, the Arts and Humanities, etc. -
-who will be consulted as to their opinions, ideas, and views.

Geneva, March 13. 1970 H0/myg/ns